



Alix™

Audio Baby Monitor / Moniteur audio bébé /
Monitor de sonido para bebé

User Manual / Manuel de l'utilisateur / Manual del usuario

⚠ WARNING • MISE EN GARDE • ADVERTENCIA ⚠

**Strangulation
Hazard!**

Children have
STRANGLED in
cords. Keep this
cord out of the
reach of children
(more than 3 ft
[0.9 m] away).

**Risque de
Strangulation !**











Enfants ont
étranglé dans les
cordons. Gardez
ce cordon
d'alimentation
hors de portée
des enfants (plus
de 3 pieds [0,9 m]
de distance).

**Peligro de
Estrangulación !**

Los niños tienen
ESTRANGULADO
en cuerdas.
Mantener este
cordón fuera del
alcance de niños
(más de 3 pies
[0,9 metros] de
distancia).



SAFETY WARNINGS

-  CAUTION: Keep small parts away from children.
-  Strangulation Hazard: Children can become entangled in cords. Power cords should be kept more than 3 feet away from the crib and baby's reach at all times. Baby monitors with power cords should never be hung on or near the crib.
-  This product is not a toy and should be kept out of children's reach.
-  This product contains small parts. Exercise care when unpacking and assembling the product.
-  Read and Keep Instructions: All the safety and operating instructions should be read before the baby monitor is operated.
-  This product cannot replace responsible adult supervision.
-  Use only with provided power supply.
-  The socket-outlet shall be installed near the equipment and shall be easily accessible.
-  RISK OF EXPLOSION IF BATTERY IS REPLACED BY AN INCORRECT TYPE!
-  Dispose of used batteries according to the instructions.
-  Use only batteries/power supplies listed in the user manual.

Water and Moisture: This product is designed for indoor use only. The unit should not be exposed to rain, moisture, dripping or splashing. No objects filled with liquid should be placed on top of, or beside the product, such as a glass or vase. This item should not be used near water.

Non-Use Periods: Always unplug the AC adapters from the wall outlets during long periods of non-use.

Ventilation: This baby monitor should not be used on a bed, sofa, rug or similar surface that may block the ventilation openings, or be placed in an enclosed area, such as a bookcase or drawer that may impede air flow.

Keep Away from Sources of Heat: This unit should not be exposed to direct heat sources such as a candle, fireplace, radiator, heat register, stove or other appliance that emits heat. The unit should not be left in direct sunlight.

Power Source: This unit should only be used with the power adapters included in this package (rated 5V ~ 600mA)

Damage Requiring Service: This unit should be serviced by qualified personnel only when:

- a. Objects have fallen or liquid has been spilled into the product
- b. The units have been exposed to rain
- c. The units do not appear to operate normally or exhibits a distinct change in performance
- d. The units have been dropped or the enclosure damaged

IC STATEMENT / DÉCLARATION IC / CAN ICES-3 (B)/NMB-3(B):

Operation is subject to the following two conditions: (1) This device may not cause interference, and (2) This device must accept any interference, including interference that may cause undesired operation of the device.

Son fonctionnement est soumis aux deux conditions suivantes:

- (1) Cet équipement ne doit pas causer d'interférences, et
- (2) Cet équipement doit accepter toute interférence, y compris les interférences capables de causer un mauvais fonctionnement de l'appareil

Changes or modifications not expressly approved by the party responsible for compliance could void the user's authority to operate the equipment.



This device complies with part 15 of the FCC Rules. Operation is subject to the following two conditions:

- (1) This device may not cause harmful interference.
- (2) This device must accept any interference received, including interference that may cause undesired operation.

FCC WARNING

This equipment has been tested and found to comply with the limits for a Class B digital device, pursuant to Part 15 of the FCC Rules. These limits are designed to provide reasonable protection against harmful interference in a residential installation.

This equipment generates, uses and can radiate radio frequency energy and, if not installed and used in accordance with the instructions, may cause harmful interference to radio communications. However, there is no guarantee that interference will not occur in a particular installation. If this equipment does cause harmful interference to radio or television reception, which can be determined by turning the equipment off and on, the user is encouraged to try to correct the interference by one or more of the following measures:

- Reorient or relocate the receiving antenna.
- Increase the separation between the equipment and the receiver.
- Connect the equipment into an outlet different from that to which the receiver is connected.
- Consult the dealer or an experienced radio/TV technician for help.

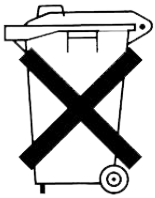

This marking indicates that this product should not be disposed with other household wastes throughout North America. To prevent possible harm to the environment or human health from uncontrolled waste disposal, recycle it responsibly to promote the sustainable reuse of material resources. To return your used device, please use the return and collection systems or contact the retailer where the product was purchased. They can take this product for environmental safe recycling.

WARRANTY INFORMATION

Please visit our website at www.mylevana.com for information about your product's warranty

We take quality very seriously. This is why all of our products come with a one-year warranty from the original purchase date against defects in workmanship and materials. If you have warranty or support issues please contact us using any of the following methods:

Web: www.mylevana.com

Support: www.mylevana.com/support

LEVANA Canada
4080 Montrose Road
Niagara Falls, ON
Canada L2H 1J9

LEVANA USA
60 Industrial Parkway #Z64
Cheektowaga NY
USA 14227

Warranty Terms

1. LEVANA® products are guaranteed for a period of one year from the date of purchase against defects in workmanship and materials. This warranty is limited to the repair, replacement or refund of the purchase price at LEVANA's option.
2. This warranty becomes void if the product shows evidence of having been misused, mishandled or tampered with contrary to the applicable instruction manual.
3. Routine cleaning, normal cosmetic and mechanical wear and tear are not covered under the terms of this warranty.
4. The warranty expressly provided for herein is the sole warranty provided in connection with the product itself and no other warranty, expressed or implied is provided. LEVANA assumes no responsibilities for any other claims not specifically mentioned in this warranty.
5. This warranty does not cover the shipping cost, insurance or any other incidental charges.
6. You MUST contact LEVANA at www.mylevana.com/support before sending any product back for repair. You will be sent a Return Authorization form with return instructions. When returning the product for warranty service, please pack it carefully in the original box with all supplied accessories, and enclose your original receipt or copy, and a brief explanation of the problem (include RA #).
7. This warranty is valid only in Canada and the continental U.S.
8. This warranty cannot be re-issued.

TABLE OF CONTENTS

Safety Warnings	2
FCC Statement	3
Warranty	4
What's Included	5
Disclaimers.....	5
Buttons and Connections	6
Setup	8
Battery installation - monitor	8
Connecting the Power Adapters	8
Turn the Monitor ON / OFF	9
Mounting the Child Unit on a Tabletop Safely	9
Placement of the Monitor	10
Power-Saving PEEP Mode.....	10
Maintenance	10
Troubleshooting.....	11
Specifications	11

WHAT'S INCLUDED

- Baby Audio Monitor
- 2 Power Adapters
- Rechargeable Battery
- Quick Start Guide
- 1 year warranty
- Lifetime Customer Support

DISCLAIMERS

Strangulation Hazard: Children can become entangled in cords. Power cords should be kept more than 3 feet away from the crib and baby's reach at all times. Baby monitors/cameras with power cords should never be hung on or near the crib. This product is not a toy.

This product contains small parts. Exercise care when unpacking and assembling the product.

Optimum range is 200 feet when signal is passing through walls or floors. Microwave ovens (when in use) may cause signal disruption at close range. Buildings with metal frames may also cause signal disruption. Maximum transmission range is 1000 feet.

Battery life of 8 hours based on full duration testing. Battery life may vary depending on usage.

This product does not replace responsible adult supervision. Check on your child at regular intervals and make sure your monitor is always adequately charged.

We reserve the right to change models, configuration, or specifications without notice or liability. Product may not be exactly as shown.

©2014 LEVANA®. All rights reserved. LEVANA®, the LEVANA® logo, Alix™ and other LEVANA® marks may be registered. All other Trademarks are the property of their respective owners.

BUTTONS AND CONNECTIONS

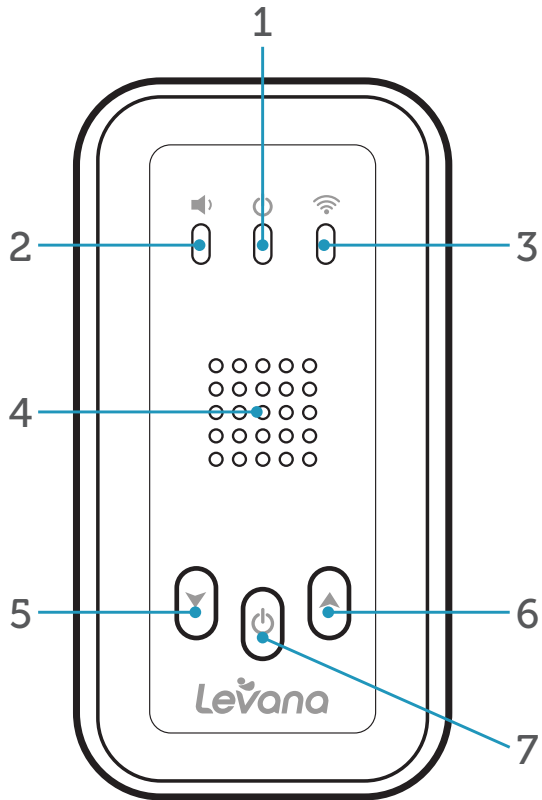

Parent Unit-Front

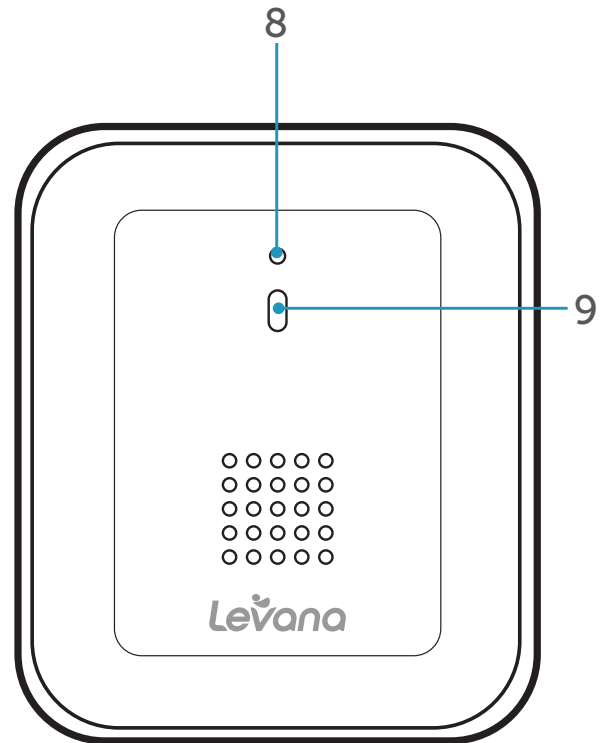

Child Unit-Front

- 1 Operating Indicator
- 2 Noise Indicator
- 3 Reception Indicator
- 4 Speaker
- 5 Reduce the Volume

- 6 Increase the Volume
- 7 On/Off
- 8 Microphone
- 9 Operating Indicator

BUTTONS AND CONNECTIONS

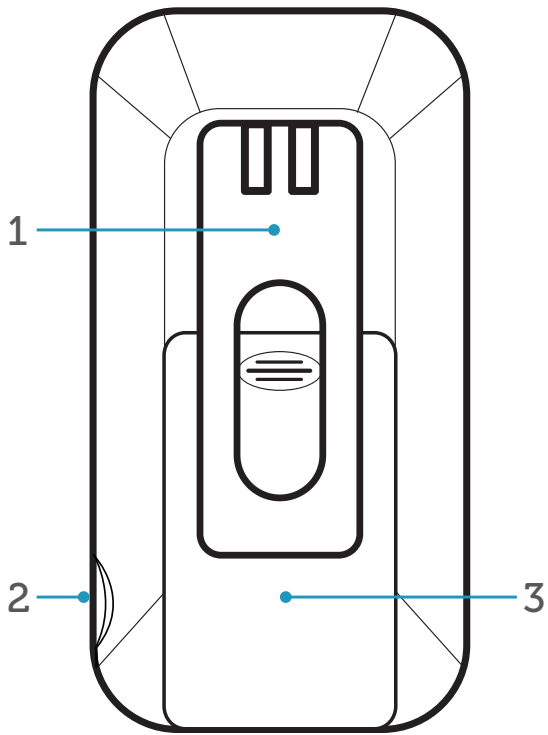

Parent Unit-Back

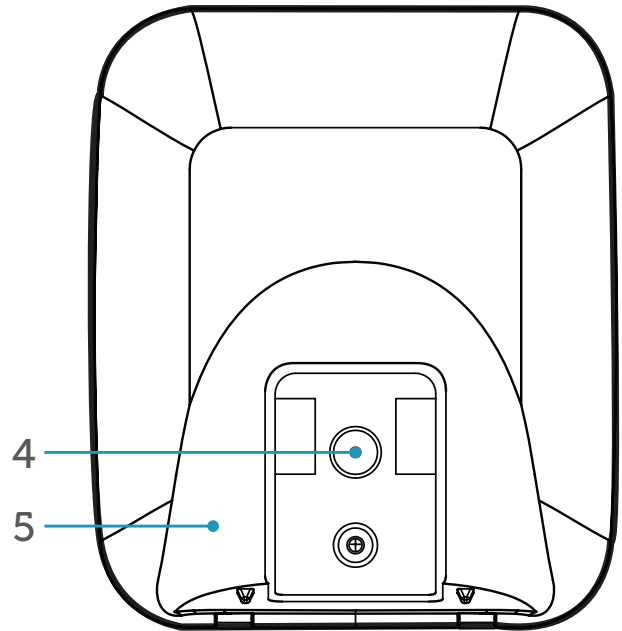

Child Unit-Back

- 1 Removable Belt Clip
- 2 Power Input
- 3 Battery Compartment

- 4 Power Input
- 5 Stand

SETUP

Battery Installation - Monitor

1. Slide the Removable Belt Clip down to allow access to the Battery Cover.
2. Slide Battery Cover down to remove.
3. Insert the included rechargeable battery
4. Plug the battery cord into the small jack on the inside of the battery compartment.
5. Slide the Battery Cover back into place.
6. Slide the Removable Belt Clip back into place.

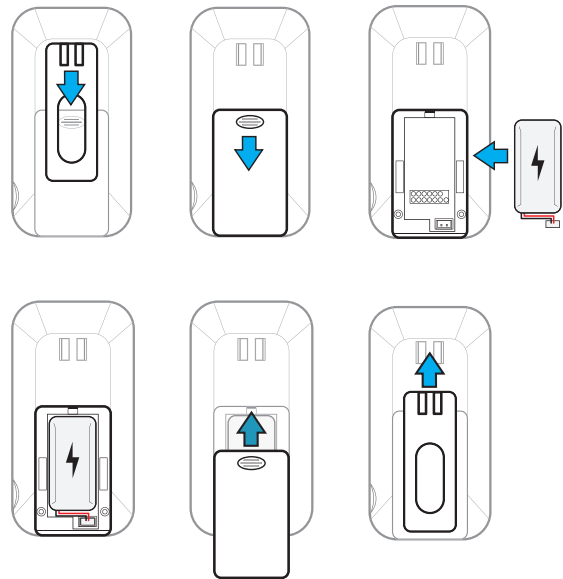

- For extended periods of non-use, please remove the battery from the Parent Unit.

Connecting the Power Adapters

1. Connect the Power Adapter to the Power Input on the side of the Parent Unit. Power LED will flash red.
2. Connect the Power Adapter to the Power Input on the back of the Child Unit. Power LED will be a solid red.

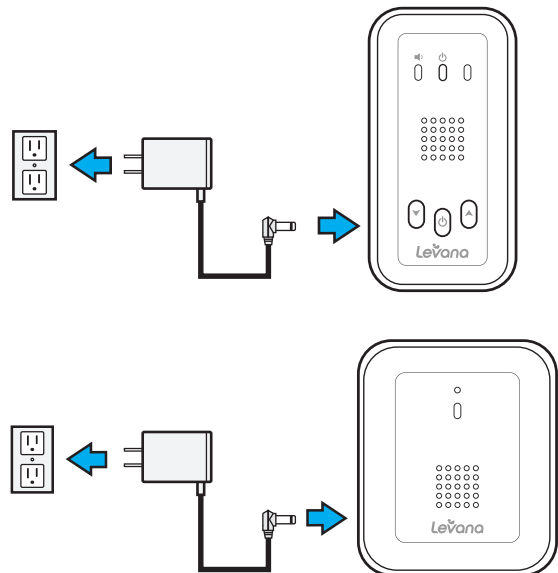

Note: Baby monitors with power cords should never be hung on or near the crib as it is a strangulation hazard. Power cords should be kept no less than 3 feet away from the crib and the baby's reach at all times.

SETUP

Turn the Monitor On/Off

1. Press and hold the On/Off Button.

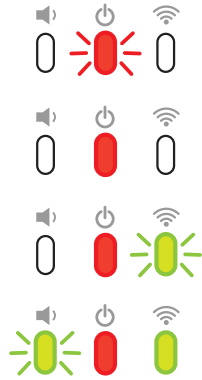
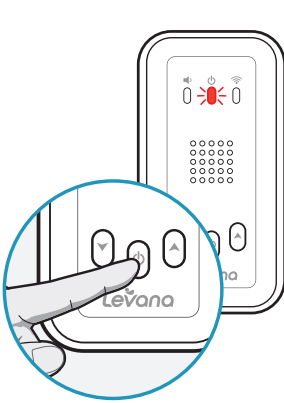

- 🔌 Flashing Red = Parent Unit Charging
- 🔌 Solid Red = Battery Fully Charged
- 📶 Flashing Green = Searching for Signal
- 📶 Solid Green = Strong Signal
- 🔊 Flashing Green = Sound detected
- 🔊 Light off = No sound detected

Mounting the Child Unit on a Tabletop Safely

1. Place the Child Unit on a tabletop no less than 3 feet away from your baby's crib.
2. Feed the power cord down the back of the table or use wall clips (not included) to secure the cord away so the baby cannot reach it.
3. Plug in the power cord, check the monitor to ensure that you can hear your child.

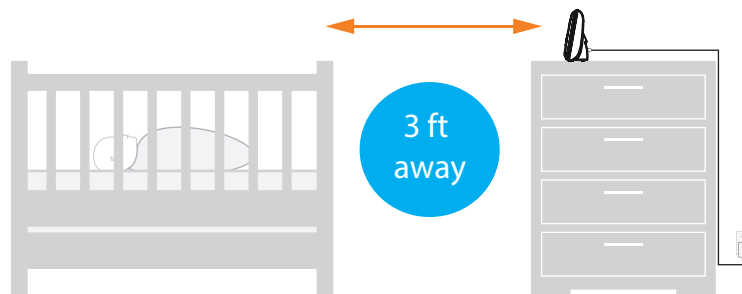

Note: Baby monitors with power cords should never be hung on or near the crib as it is a strangulation hazard. Power cords should be kept no less than 3 feet away from the crib and the baby's reach at all times.

SETUP

Placement of the Monitor

The monitor can be used two different ways; attached to your belt or mounted on the wall.

- Carry the monitor on your belt by sliding the clip over your belt.
- Hang the monitor from a screw on the wall using the screw mounting hole in the belt clip.

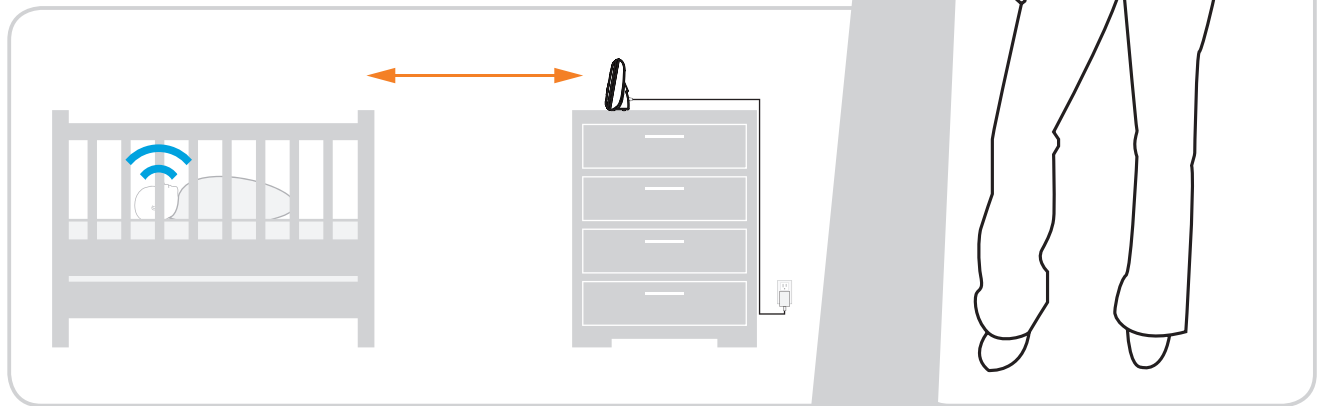

Power-saving PEEP mode

Voice activated technology helps conserve battery life by putting the system into hibernation mode when sounds are not detected for 30 seconds. If your child starts to cry or make noise, the unit will automatically detect it and the Noise Indicator on the Parent Unit will flash. The preset noise level is preset to a level comparable to a casual conversation.



- 🔊 Flashing Green = Sound detected
- 🔊 Light off = No sound detected

MAINTENANCE

Mounting the Camera on a Tabletop Safely

- Clean the surfaces of the Parent and Child units with a soft, fluff-free cloth.
- If the units become dirty, use a lightly damp cloth to wipe surfaces, taking care to not allow water into any openings.
- Never use cleaning agents or solvents.

TROUBLESHOOTING

ISSUE	POSSIBLE SOLUTION
Equipment does not function	<ul style="list-style-type: none"> • Confirm that the Parent and Child units are ON • The battery may be depleted; charge battery • The power adapter(s) may not be properly connected
No reception	<ul style="list-style-type: none"> • Camera and monitor may not be properly paired; move the Parent and Child units closer together
Reception Interference (static)	<ul style="list-style-type: none"> • The Parent and Child units may be too far apart • The battery power may be too low • Other electronic devices may be interfering with the signal • The Parent and/or Child unit may be placed too close to many metal objects
Noise (static, beeping)	<ul style="list-style-type: none"> • Battery power may be too low
The rechargeable battery will not charge	<ul style="list-style-type: none"> • The power adapter may not be connected • Battery pack may not be properly connected inside the battery compartment

SPECIFICATIONS

PARENT UNIT		CHILD UNIT	
Wireless Frequency	Digital	Maximum Wireless Range	1000 ft
Channel Frequencies	2.4 GHz	Optimum Wireless Range	200 ft
Speaker	Yes	Speaker	No
Microphone	No	Microphone	Yes
Battery Operable	Yes, Rechargeable	Battery Operable	No
Battery Type	NiMH	Operating Temperature	32°F to 104°F (0°C to 40°C)
Battery Life	8 Hrs	Housing Material	ABS Plastic
Charging Time	8 Hrs	Housing Color	White/Gray
PEEP Mode	Yes	Power Adapter	5V ~ 600mA
Operating Temperature	32°F to 104°F (0°C to 40°C)	Dimensions	3.54 x 2.75 x 1.5 in 8.99 x 6.98 x 3.81 cm
Housing Material	ABS Plastic	Weight	0.1 lbs
Housing Color	White/Gray		
Power Adapter	5V ~ 600mA		
Dimensions	4.25 x 2.25 x 1.25 in 10.79 x 5.71 x 3.17 cm		
Weight	0.15 lbs		

NOTES